

4

3

2

1

B

B

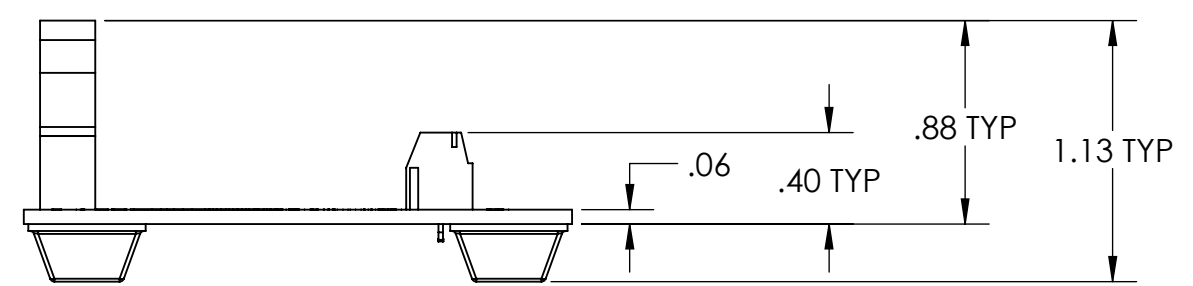
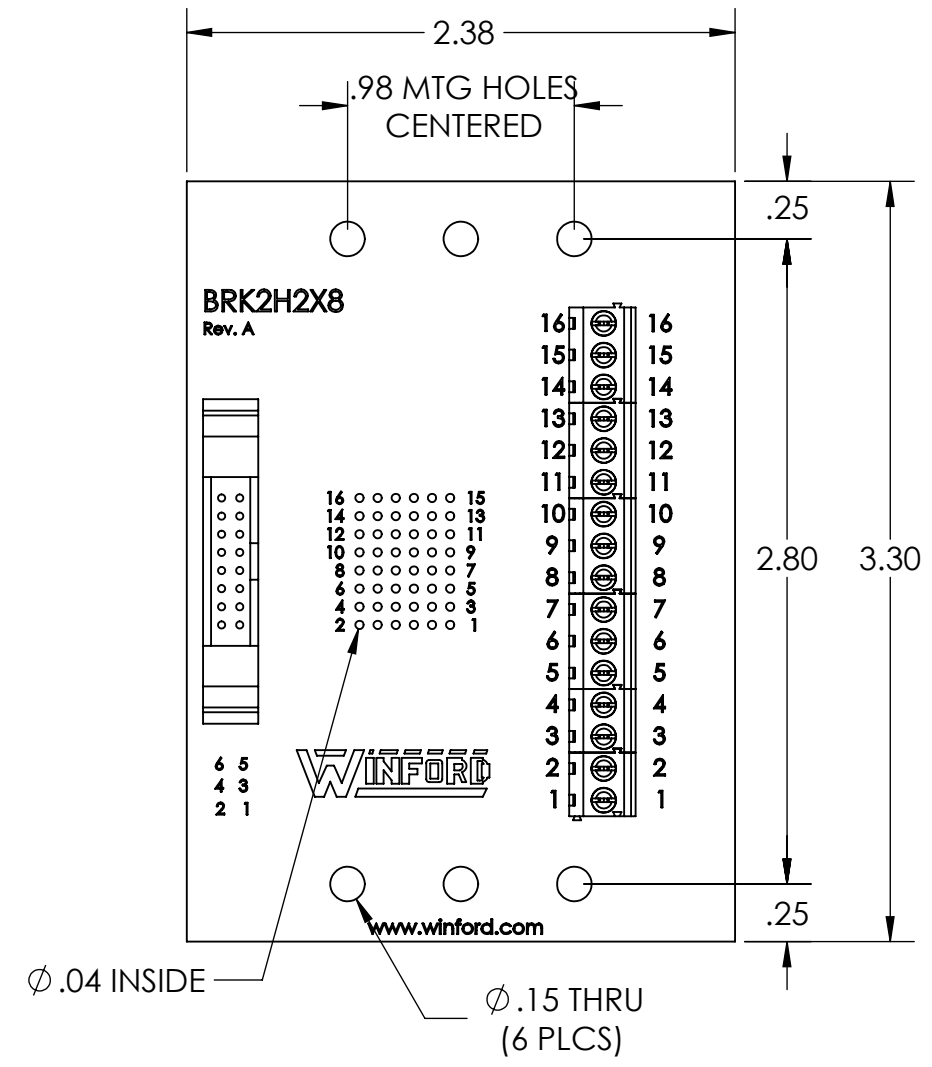
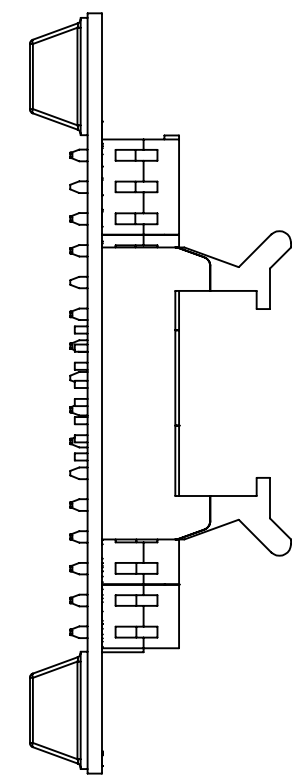

A

A

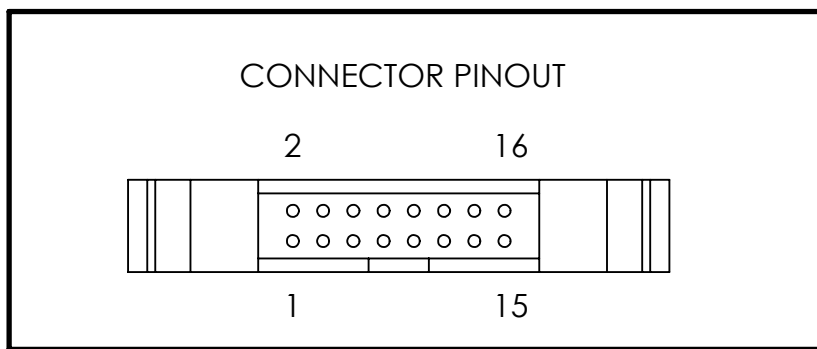

DIM: INCH	DATE: 08/19/2022	RoHS COMPLIANT: YES	DESCRIPTION:
WINFORD ENGINEERING, LLC 4561 GARFIELD ROAD AUBURN, MI 48611			2x8 2mm Header Breakout
www.winford.com		989-671-9721	PART NUMBER (S)
			BRK2H2X8-L-FT
			PART REVISION
			A

4

3

2

1