

4

3

2

1

B

B

A

A

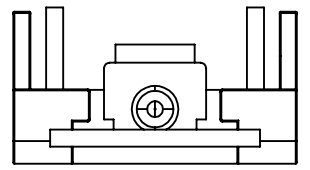
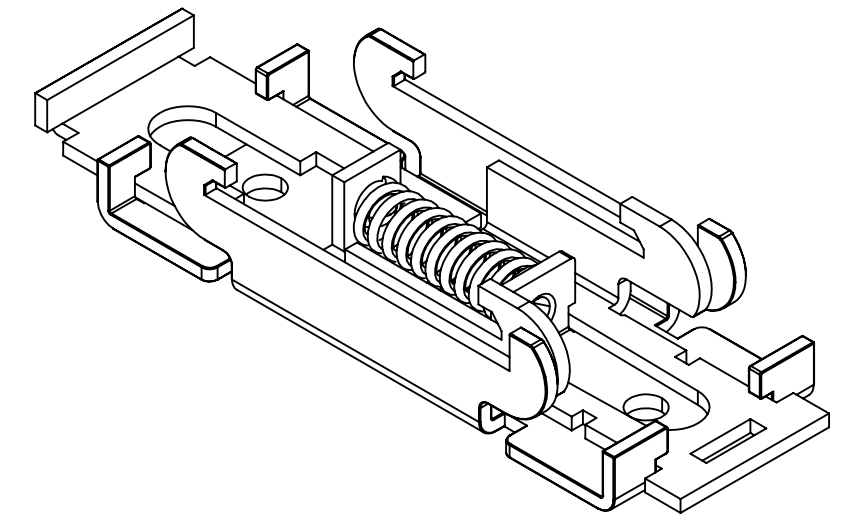
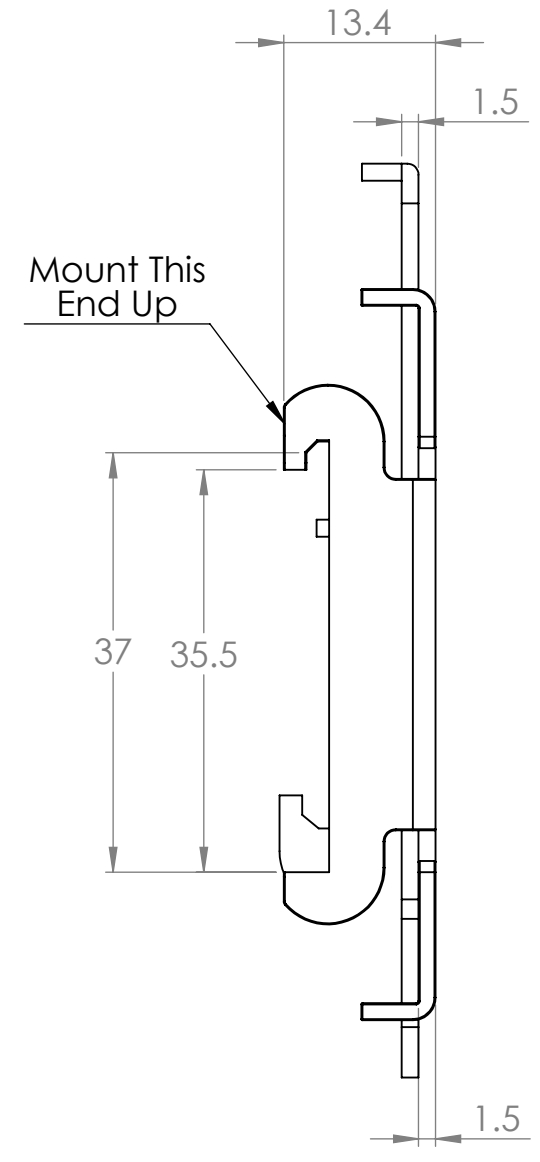
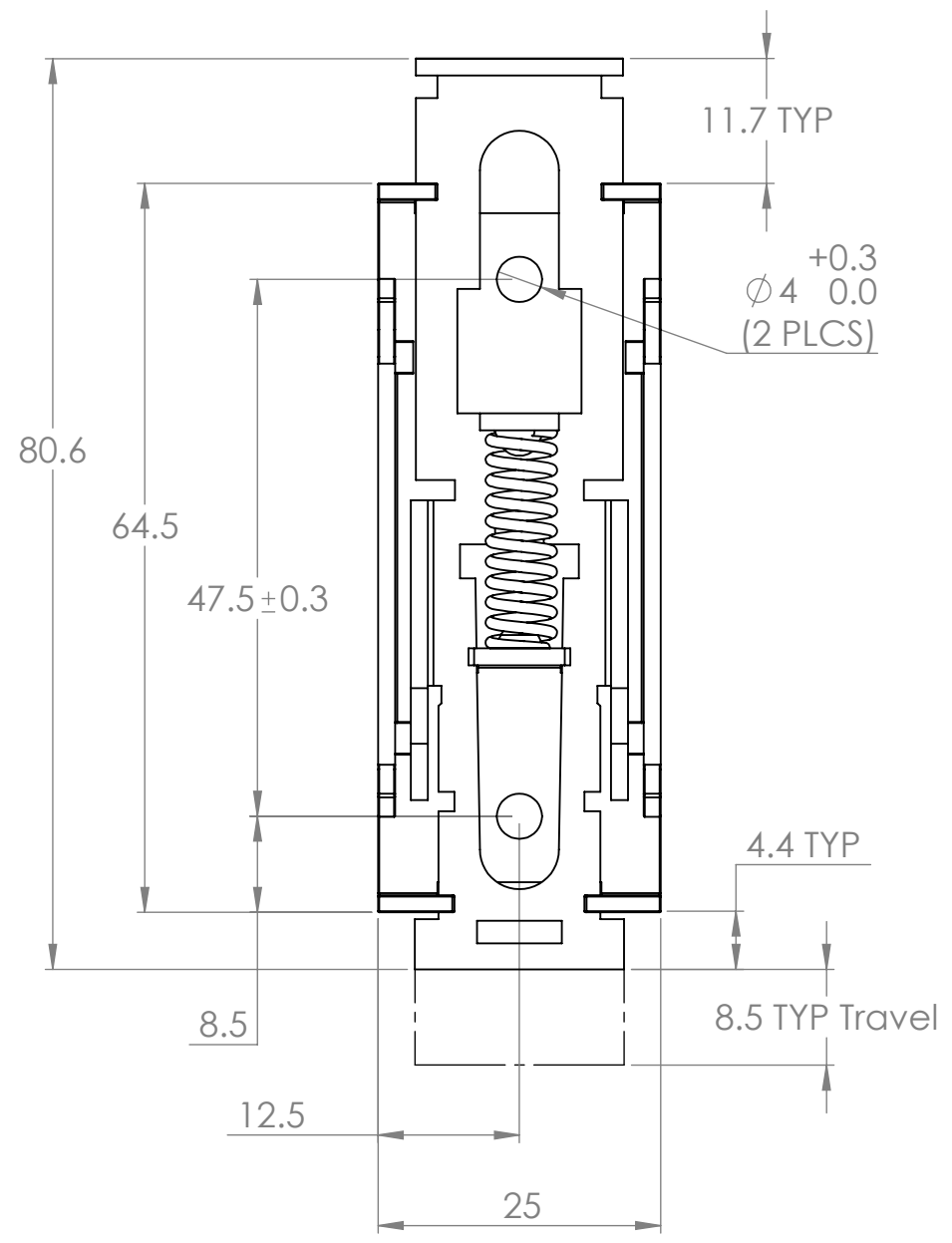

Material: Steel, Nickel Plated

DIM: MM	DATE: 07/18/2022	RoHS COMPLIANT: Yes	DESCRIPTION:	
 WINFORD ENGINEERING, LLC 4561 GARFIELD ROAD AUBURN, MI 48611			Steel DIN Rail Mounting Clip, 25mm width, Through Holes	
			PART NUMBER (S)	PART REVISION
www.winford.com			DINM23U40	A

4

3

2

1